



FS580+

User Manual

Safety instructions

About the product

- For your safety, please do not watch the video or operate the product while driving. To install and set up this product, please park your car in a safe place first.
- Please read this User's Manual before operating the product.
- Do not install the product in a place where it may cause interference with the use of the product.
- Do not use the product in high temperature and highly humid environments.
- Please do not leave this product in direct sunlight for a long time to avoid reducing the life of the product. When not using the product, please store the product in a dry environment at room temperature.
- If the machine breaks down during use, do not disassemble or repair it yourself, but contact your local product dealer.

About car chargers

- Please use the charger provided by the original manufacturer. Using a non-original charger may cause malfunction or danger.
- Please do not keep inserting and removing the car charger to avoid damage.
- Do not touch the car charger when your hands are wet.
- If the car charger is damaged, do not try to repair it yourself, but replace it immediately.

About Batteries

- Some models have built-in batteries, please avoid using them in high temperature environment.
- Because the battery will be automatically discharged even when not in use, so when the machine needs to be idle for a long time, please put the host in a dry environment at room temperature to avoid excessive battery discharge in a low state resulting in the inability to boot up, such as the occurrence of the host can not boot up, please connect the host to the power charge for a few minutes and then turn on.

Other Description

Product Upgrade

Please go to the DOD website to download the latest software. When downloading the latest software, please check the system version first (if the host's current software version is higher than the version released on the official website, it is recommended not to change the software).

- Connect the memory card in the host to the computer with a card reader.
- Go to the DOD website and search for [corresponding product model] Support → Update and Download. After downloading, please extract the update file and copy it to the root directory of your memory card.
- After copying, insert the memory card into the host computer, connect the power, the machine will automatically run the upgrade program, and the machine will automatically boot up after the upgrade is completed.
- After the product upgrade is completed, please have the host system formatted to avoid repeating the update the next time you boot up.

About Memory Cards

- It is recommended to format the memory card about every two weeks to ensure that the card works properly.
- It is recommended to use Class C10 U3 V30 or above, MLC process memory card (3000~10000 write count). Memory card capacity depends on the model: Memory cards up to 256GB are supported.
- Do not remove the memory card directly when the device is turned on. It is recommended that you turn off the device before removing the memory card to avoid damaging the recorded files on the memory card.



NOTE:

The memory card is a consumable item and must be replaced by a new one depending on the usage.





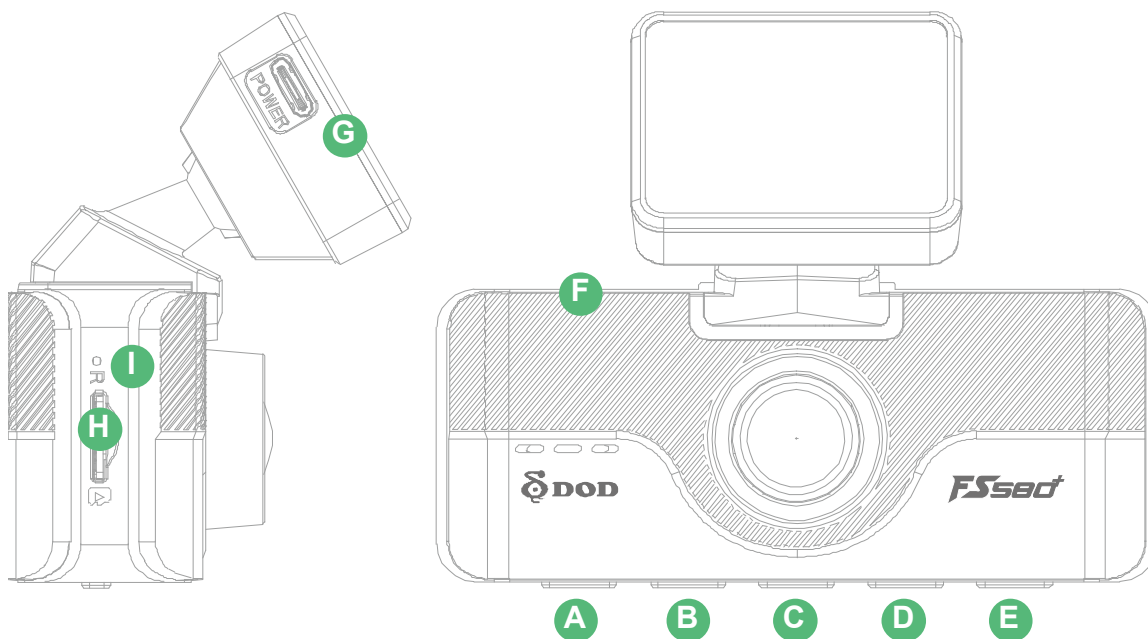



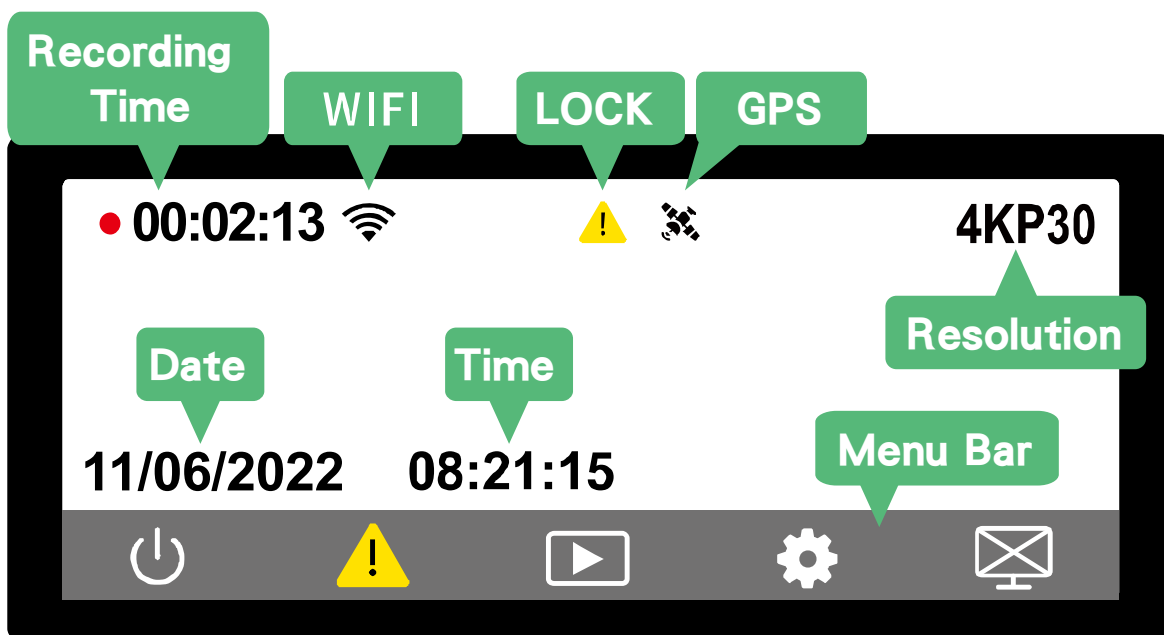



Buttons and screen display

* Button functions and screen displays vary by model



- A. Subnet switching / WiFi
- B. Microphone / Downward
- C. Confirmation / Playback
- D. Upward / Recording
- E. Power Switch / Menu
- F. Rear lens connection port
- G. Power port
- H. Memory Card
- I. Reset key



Mode	Button	Description
Standby / Recording Mode		Switch on/off
		Short press: Lock file Long press: capture in video
		Short press: Go to playback Press and hold: Switch to record on/off
		Short press: Go to setting menu Press and hold: Switch on/off recording
		Short press: switch the front and back lens display screen Long press: Switch WiFi on/off
Settings / Playback		Switch on/off
		Top Menu
	OK	Confirmation
		Next Menu
		Back
WiFi mode		Switch on/off
		Locking File
	SSID	SSID display
		Snapshot in the video
		Short press: switch the front and back lens display screen Long press: Switch WiFi on/off
LED Lamp No.	Lamp Number	Description
	Red Light	In the video
	Green Light	WiFi mode

Installation

Installation location and alignment

*Drawings are for reference only, subject to the real thing

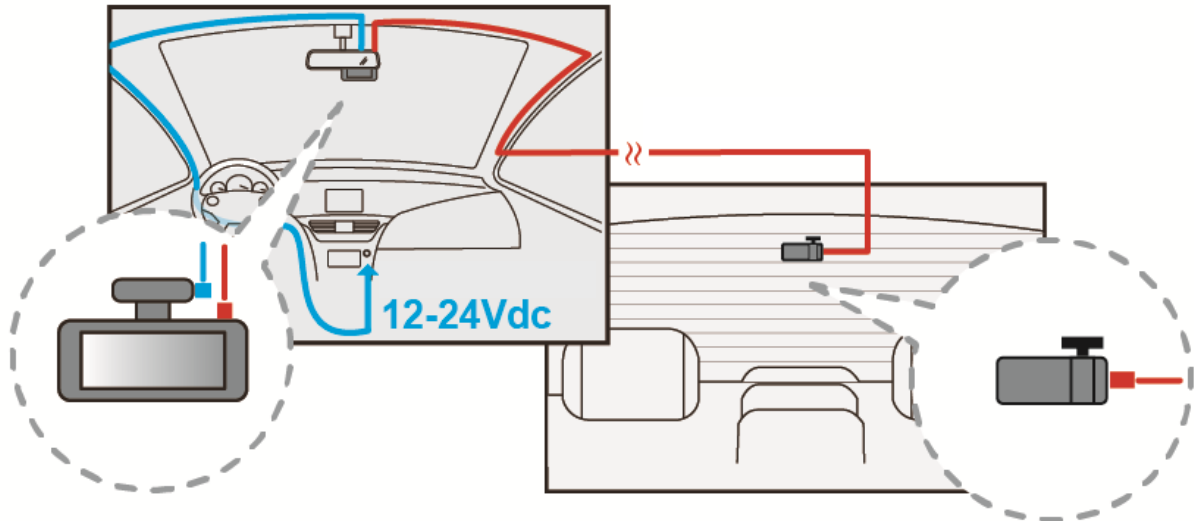

Cleaning windshields

Installation

Find a suitable location on the car, not blocking the driver's view and safety, install the bracket and hang the machine.

Adjust the lens angle

Adjust the angle of the lens by adjusting the angle of elevation of the main unit to make sure it is level with the ground.

*Do not forcefully twist the cable set inside the ball head of the bracket to avoid damage to the bracket.

Memory Card

Please insert the card into the host according to the card slot icon []. To ensure that the card can be used normally, please format the card with the host first.

*Formatting will delete all the data in the card, so please keep the important data first.

Connected Power

Before connecting the power, **please be sure to first connect the host and rear lens USB cable installation is complete**, finally connect the car charging power to the car to reduce the host and rear lens damage chance.

NOTE:



- Please use the original car charger to avoid damage caused by non-compliance with the specifications.
- If there is oil, fingerprints or other dirt on the inside or outside of the windshield, wipe it clean before installing it.
- When using the bracket, please choose the position carefully. Do not place the main unit in a position that will obstruct the view of driving or affect the normal operation of the airbag.
- Road conditions vary from country to country, so it is recommended to set the gravity sensor to "low" to avoid frequent gear locking.

Turn on and off

The machine will automatically turn on and start recording when the vehicle is started, and will automatically turn off when the vehicle is turned off and the power is cut.

NOTE:



For certain models, the power will not be cut off immediately when the vehicle is turned off. This situation may cause the machine to continue to consume power, which may lead to the depletion of the vehicle battery.

Constant Power

If your vehicle recorder is connected to a constant power source, simply unplug the USB power source after the engine is turned off to turn it off.

Watch the video

The video will be stored on a memory card, which can be watched in playback mode by the camera or by inserting the card into a computer.

The files on the card will be categorized as follows:

- Loop recording clip: The length of the video varies depending on user settings.
- Video folder is VIDEO
- Lock the file folder to EMERGENCY

Example.

Previous video file name: **20220601192757_000001A**

Post-camera video file name: **20220601192757_000001B**

*The string represents the date and time the video was shot (in the order of year, month, day and 24 hours)

WiFi

※ **This function is available for models with WiFi capability.**

Please scan the QR code link to APP store to download the latest version of "DOD Dashcam" APP to your smart device.



Android



iOS

Note:

- DOD Dashcam APP supports version iOS7 or above Android4.5 or above.
- As each model varies, it is recommended to update your smart device to the latest version.

Link Description

1. Press the Wi-Fi switch on the machine → Open AP mode → Use your phone or tablet to connect to the machine Wi-Fi and enter the password → After the connection is completed, you can start the operation.

Preset password: 12345678

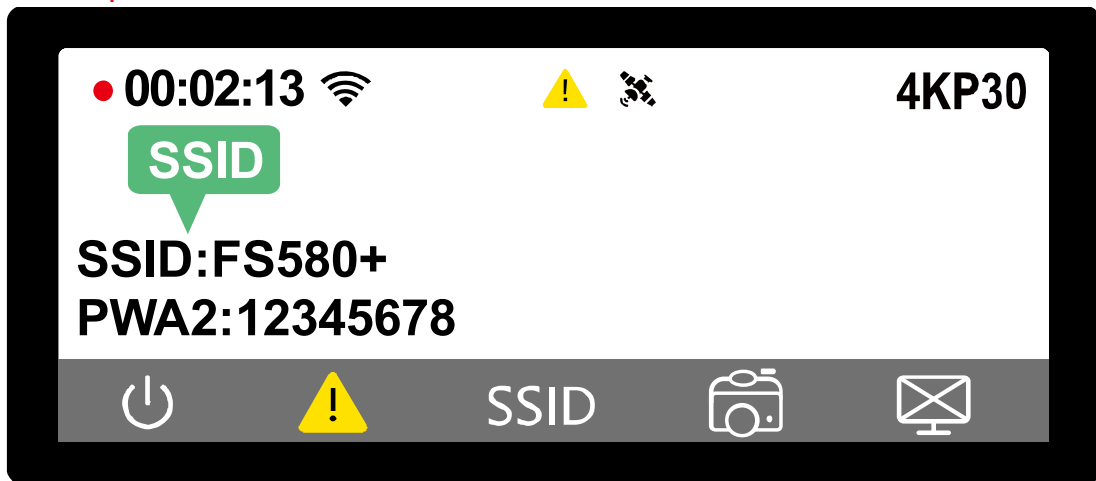

2. After opening the APP, click the camera icon to enter the camera list, click the link icon of the model you want to connect, then finish the APP connection.
3. Or follow the image step-by-step instructions in the App Help Guide to link.

Note:

- The Wi-Fi password only needs to be entered the first time you connect, and if it is not changed, you can skip the password entry for the next connection.
- The password can be changed within the app, and is limited to English semi-formats, with symbols and spaces disabled.
- Wi-Fi connectivity varies depending on the distance and environment, and the recommended range is within one meter.



① Switching front and rear camera display

② Capture the moment

③ Cell phone brightness adjustment

④ Turn on/off recording

⑤ Return to Link Control page

⑥ File Browse

⑦ Turn on/off recording

⑧ Settings

⑨ Google Map

*Need to turn on the phone GPS function

Function Setting Menu

※ The menu varies depending on the model, so please refer to the update instructions released with the firmware for adding, deleting or changing features.

Press [] once to enter the function setting.

Function	Options	Preset value
Resolution	4KP30 / 1600P30 / 1440P60 / 1440P30 / 1296P30 / 1080P60 / 1080P30 / 720P120	1440P30 Single front mirror
	4KP30+1080P30 / 1600P30+1080P30 / 1440P30+1080P30 / 1296P30+1080P30 / 1080P30+1080P30	4K30+ 1080P30 Double Mirror
Video format	TS / MP4	MP4
Screen Display	Front lens / Back lens / Sub screen	Mother and Child Screen
Loop Recording	1 minute / 3 minutes / 5 minutes	1 minute
Date/time	2022 / 01 / 01 / 00:00:00	
WiFi	Open / Close	Close
Recording	Open / Close	Open
GPS Status	Watch GPS Receiving Status	
Parking Monitoring	Close / 1 second 1 shot	Close
Crash Sensitivity	Close / Low / Medium / High	Close
WDR	Open / Close	Close
Film Marker	Time / Time + Latitude / Time + Latitude & Longitude hourly speed	Time
Image editing format	H.264 / H.265	H.265
Rear lens mirroring	Open / Close	Close
Exposure settings (before)	-1.0-2/3-1/3+00+1/3+2/3+1.0	00
Exposure settings (after)	-1.0-2/3-1/3+00+1/3+2/3+1.0	00
Key Tone	Open / Close	Open
Screen Protection	Close / 1 minute / 3 minutes	1 minute
Language	Traditional / Simplified Chinese / English	
Formatting Memory Cards	All data will be deleted after formatting the card Cancel/Confirm	
Formatting Tips	Close / 15 days / 30 days / 60 days	60 days
Restore the original factory settings	Restore appearance settings and menu cancel/confirm	

Product Specifications

Recording Resolution	Front: 3840x2160@30fps Rear: 1920x1080@30fps
Light-sensitive element	SONY STARVIS CMOS Sensor
Wide angle lens	140°
Aperture	f/1.7
Video format	MP4 / TS
Compressed Format	H.264 / H.265
EV value	Independent adjustment of front and rear lenses
WiFi	2.4G support
Battery	Jin Danyong
Audio	Built-in microphone/speaker (mono)
Recording Media	SDXC Class 10 or higher, supporting up to 256GB Memory card (*Recommended to use U3 high-speed read/write memory card)
GPS speed warning	YES
G-SENSOR	YES
Manual gear lock	YES
Loop Recording	YES
Parking Monitoring	YES (*Optional parking power shield required)
Power	5V 1.5A
Size	Front: 95(L) x 48(W) x 73(H) mm Back: 70(L) x 40(W) x 40(H) mm
Weight	Before: 125g After: 30g
Temperature	-20°C~65°C (-4°F~149°F)

DOD Warranty Terms

DOD LIMITED WARRANTY		
Product Category	Warranty Period	Note
Camera	1 years	Warranty period is effective on the date of purchase of the product from DOD's authorized dealers. Malfunctions and damage caused by misuse, neglect, natural disasters or abnormal electricity currents will not be covered by the warranty.
Battery	6 months	
Parts & Accessories	6 months	

1. Please keep the invoice and warranty card.
2. If the invoice or warranty card for the camera is missing, please provide the device's serial number to DOD customer service so that the warranty can be fulfilled.

The product is not included inside the warranty :

3. Malfunctions and damage caused by misuse, neglect, natural disasters or abnormal electricity currents will not be covered by the warranty.

All rights reserved by DOD Tech Co.,Ltd

Guarantee Certificate

Product	Model No.
Serial No.	Date of Purchase
	/ /
<p data-bbox="489 1276 1020 1318">DOD authorized distributor</p> 	

Copyright ©2023 DOD Tech Co., Ltd.
All Rights Reserved

Under the copyright laws, this manual may not be copied,
in any way, shape, or form, without the written consent of DOD Tech Co., Ltd.